

Your guide to
applying for a

Service Alteration



Scottish & Southern
Electricity Networks

Introduction

The purpose of this guide is to help you understand what is involved in carrying out your Service Alteration work and how we, Scottish and Southern Electricity Networks, can help make this happen as smoothly and as quickly as possible.

Please read the following carefully as it includes important information about the responsibilities of the different parties who will be involved in your Service Alteration including the most important person, you.

Making it happen

The process is very simple. Here is a rundown of the Service Alteration process

1. Applying for a Service Alteration

2. We will prepare your quote

3. Sign and Pay for your quotation
(Valid for 90 days)

4. We will settle any wayleaves

5. Our team arrives on site

Every project is different so it is difficult to give exact timescales. However we will - from application form to full installation - make sure that you know how things are progressing

What is a Service Alteration

A service alteration is not a new connection but a change to the location of your supply point and meter. Perhaps you are renovating your property, building an extension, or demolishing a part of the property, all of which means the electricity meter is in the way and requires relocating. Alternatively, you may be a developer who wants to convert their permanent connection to a Temporary Building Supply (TBS) or the other way around.

1. Applying for a Service Alteration

How do I apply?

Are you planning to have building or renovation works at your property? Do you need your electricity supply point and meter moved to a new position?

Applying for a Service Alteration is easy, you can do this online by completing an application. Once you've applied, you can track the progress of the application here too.

Please view our useful Service Alteration video to help guide you through the process:
www.ssen.co.uk/Forms/Onlineapplications/connections/servicealteration/video/

Online

This can be done online via our website, where you can register an account with us so you can apply, track, and pay for your works all online at www.ssen.co.uk/Forms/Registration/



Offline

You can also apply offline by downloading one of our application forms from our website at www.ssen.co.uk/ConnectionServices/ChangingOrMovingYourSupply/MovingYourMeter/

once complete you can email this back to us at connections@ssen.com



Phone

You can also apply over the phone with our application team who can be contacted on 0800 048 3516



1. Applying for a Service Alteration continue

When you submit your application, we ask that you include some extra information to ensure we can design your Service Alteration accurately for you.

The information we need from you will include;

- Your contact details and correspondence address
- Contracted Party Details (Who is paying for the works)
- Address and postcode of the site
- A plan showing current and proposed position of your supply (please note the new location of your supply must not be situated in a kitchen, bathroom, bedroom or too low to the floor in an under stairs cupboard)
- The distance it needs to be moved
- Whether your supply is single or 3 phase connection (Don't worry, we can access this information if you are unsure)
- Site Location Plan. Suitable location plans can be obtained by using websites such as:
 - <https://www.google.com/maps>
 - <https://gridreferencefinder.com>

What do we do with your application?

We will contact you when we have received your application and provide you with a date when you should expect to receive your quotation. We will also provide you with a unique job number.

2. We will prepare your quotation

Once we have all the information we need, we will design and send you a quote.

A Quoter may contact you if they require any further information.

Please note, it is not always necessary for us to visit your site in order to provide a quotation where we can we produce our quotations from the desktop.

We will provide you with a quotation within 5 to 25 working days depending on what works are involved in carrying out your service alteration, if this is part of a larger project this can take up to 3 months.

One of our quoters will be in touch to make sure you're happy with the information we sent you and answer any questions you have.

3. Sign and pay for your quotation (valid for 90 days)

Once you have received, reviewed and are happy with your quotation, there are several ways you can accept and make payment for your connection.

You can do this online or over the phone by card, or through BACS or cheque.

Once we've received the payment, we will then contact you to schedule your job.

What happens next?

Our delivery team will be in contact within 7 working days of payment to offer an appointment for the works to be carried out.

Other parties to contact

You will need to contact your supplier as soon as possible as they will need to come after 13:00hrs the same day as us to move your meter and have your electrician standing by to connect your supply internally. Please note, until these steps have all been taken your power will remain off. If your supplier is unable to attend on the same day as us, then please let us know so we can re-arrange and to avoid any abortive call fees.

Not sure who your supplier is? You can find out here: <https://www.ssen.co.uk/Whoisyoursupplier>

Whoisyoursupplier

How it all fits together

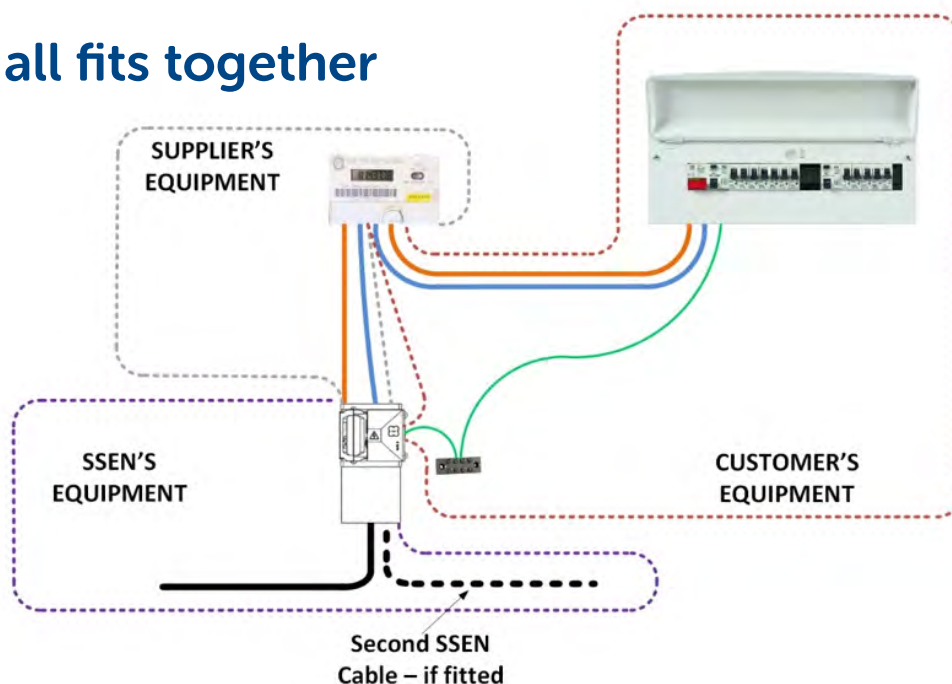

4. We wil help you settle any wayleaves

We will check to see if we need to cross any neighbouring land to connect the new electricity cable position to your property. If this is needed, we may need to gain permission from the land owners. Don't worry though, if this is needed, we'll handle this for you.

Whilst every effort is taken to obtain wayleaves as quickly as possible, we are reliant on the cooperation of your neighbours or other third parties.

We do advise you start the conversation with your neighbours in advance as this can help speed up the process for you.

Please keep the following points in mind while you plan your project:

- **The time it takes to obtain wayleaves from your neighbours or other third parties, may affect your project's delivery. Some third parties can typically take between 12 and 16 weeks to grant us the necessary consents and in other cases considerably longer. The Wayleave Officer responsible for your project will progress these consents and keep you fully informed.**
- **The price on our quotation is given subject to all wayleaves being agreed. However, you may incur additional costs for specific wayleave issues.**
- **A new design and quotation will be required if wayleaves are refused**
- **No works can be undertaken on third party land until wayleaves have been agreed**

5. Our team arrives on site

The final step is for us to complete the work you've asked us to do. Our team will arrive on site on the agreed date to carry out the works.

Your onsite responsibilities

- Ensure that the premises are securely locked and weather tight
- Arrange for your supplier to attend site to move your meter the same day. Not sure who your supplier is? You can find out here: <https://www.ssen.co.uk/Whoisyoursupplier>
- Your electrician is required to reconnect your consumer unit/fuse board to the meter
- If you think you are not going to be ready on the agreed date, please contact us as soon as possible. Ideally you should give us a minimum of 5 days' notice. If we arrive on site and you are not ready, we will be unable to commence our works and may charge £150 for the abortive visit.

Customer on site work guide



Contents

Cable trenches.....	09
Cable ducting.....	10
Trench backfilling and reinstatement	10
Internal main fuse positions quick guide	11
Internal meter positions	11
External main fuse positions quick guide	12
Consumer unit internal wiring	13

**In an emergency situation
call 105 immediately for help**



Cable trenches, routes and depths

If you damage any of our underground cables you must report it to the Emergency Service Centre immediately by calling 105.

All trenching works must be carried out in accordance with our technical guidance Installation of Electricity Service, Intake and Distributor Cables up to and Including 33kV available from the SSEN website. www.ssen.co.uk/CompetitionInConnections/G81Documents/

The drawing included with your connection offer shows where you are required to dig and fill cable trenches and joint bays.

The following trench section shows the position of duct in the ground. It is important that the top of any apparatus is at these depths as a minimum, this includes the top of the duct.

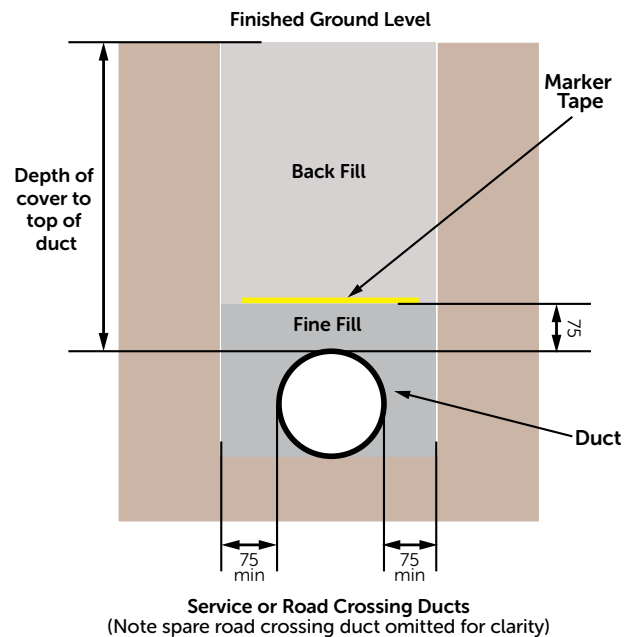

Depth of cover for cable and cable ducts

Location / Voltage	LV Service
Unmade & cultivated ground	450mm
Footpaths	450mm
Roadways	600mm
Agricultural land	1000mm

Yellow unbranded or SSEN-branded cable marker tape must be installed above the fine fill. You will need to supply the fine fill material (for example builders sand) to surround the cable or duct by 75 mm on all sides.

For all overhead supplies, if you have a pole within your property boundary, you should only excavate within 1 metre of the pole and SSEN will do the rest.

Please ensure that ducts provided for our use are spaced at least 1000mm clear of inspection pits and other duct lines to ensure adequate working clearance at the end of the ducts.

Ducting cables on site

For more detailed information on the ducting of cables please see our technical guidance document **Installation of Electricity Service, Intake and Distributor Cables up to and Including 33kV** available on our website.

www.ssen.co.uk/CompetitionInConnections/G81Documents/

Ducting of service cables

The drawing provided with our connection offer shows where you are required to install ducting.

Minimum internal diameters of ducting are given in the table below:

Cable type	Minimum Internal Diameter
Single phase service cable	32mm
Three phase service cable	50mm-100mm

For single phase service cables, you are required to install a 32 mm internal diameter black electrical duct from the joint position advised by SSEN to the position of the proposed service termination.

For three phase service cables, a 50mm internal diameter black duct can be used although it is recommended a 100mm duct is used for long lengths.

Ducts should be laid straight where possible with a minimum number of bends, and shall be marked with Yellow unbranded or SSEN-branded cable marker tape.

Please refer to your design with regards to installing your ducts. Where bends are required please discuss with your Connections Project Manager.

It is important that you provide a draw wire or rope in the ducting to allow us to pull the cable through. You will be responsible for clearing the ducting if it gets blocked.

Please discuss sealing the ducts with your connections delivery manager

Trench backfilling and reinstatement

The customer shall reinstate the trench up to the joint position, leaving at least 1-metr trench available for SSEN, who will backfill the cable trench up to the marker tape position and will install the marker tape over the joint.

Internal main fuse (cut-out) positions

If you choose an internal termination position (where your meter operator will install the meter) follow our handy hints below.

Quick Guide

It must be:

- ✓ Located on the inside face of an external wall
- ✓ If applicable, gas meters must be located at least 300mm away from electrical equipment, and the space must be well ventilated

Must not be:

- ✗ In a cellar, toilet, bathroom, kitchen, bedroom, under stairs with headroom less than 2m
- ✗ Over a doorway
- ✗ On a partition stud dry-lined wall
- ✗ Or any other position not complying with the IET Wiring Regulations.

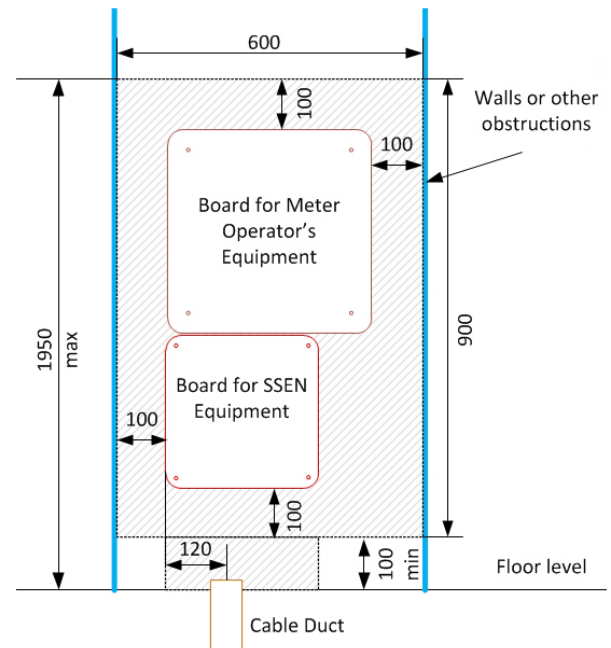

Wall space required for a single phase supply

Meterboard size for SSEN Equipment 300mm x 300mm

Meterboard size for Meter Operator Equipment 400mm x 400mm

Internal meter positions

Meter board sizes and locations will depend on the type of supply being installed. Please see the illustration for guidance.

You must ensure that any electrical installation work beyond your supplier's meter is carried out by a qualified electrical contractor to the requirements of the current BS 7671, The IET Wiring Regulations. The length of cable between the meter and the consumer unit must not exceed 3 metres.

Meters should be situated on the inside face of an external wall as close as possible to the incoming mains service and must not be installed in passageways that are designed as fire escapes, or where they could be enclosed, such as behind locked gates or in bin stores. Service terminations must not be installed in cellars, toilets, bathrooms, kitchens, bedrooms, under stairs with headroom of less than 2m, over doorways, on partition, stud dry-lined walls or any other position not complying with BS 7671.

Gas meters, where installed, must be at least 300 mm away from the electrical equipment with gas pipes at least 50 mm. The space must be well ventilated.

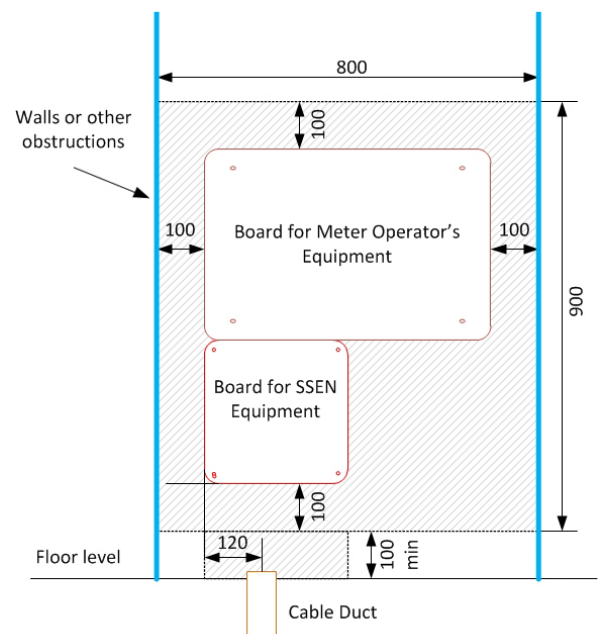

Wall space required for a three phase supply

Meterboard size for SSEN Equipment 300mm x 300mm

Meterboard size for Meter Operator Equipment 600mm x 400mm

Shaded area to be kept clear of obstructions

External main fuse (cut-out positions)

If you prefer an external meter position, please follow our handy hints below.

Quick Guide

You must:

- ✓ Supply the meter cabinet. They can be purchased from some builders merchants, and come complete with a hockey stick duct or cable cover.
- ✓ Meter cabinets come in various sizes, please ensure that you have the correct one for your alteration, these are shown in our drawings, but in addition you will need to request either a single phase or three phase box to match your supply.
- ✓ Ensure the service cable duct is securely coupled to the hockey stick.
- ✓ Ensure that meter cabinets located next to each other have labels fitted inside to identify which premises they feed.

Cabinets must not be:

- ✗ Installed where it could be enclosed, such as behind locked gates or in bin stores.
- ✗ Installed in passageways that are designated fire escapes.

Flush Mounted with Hockey Stick in Cavity

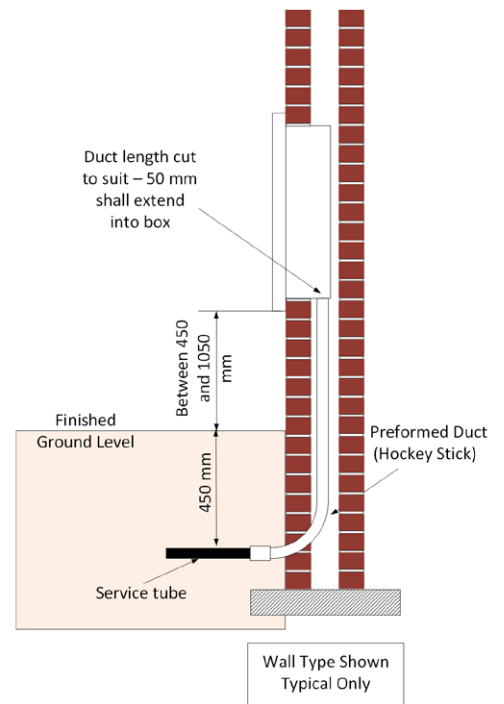

Surface Mounted with External Hockey Stick

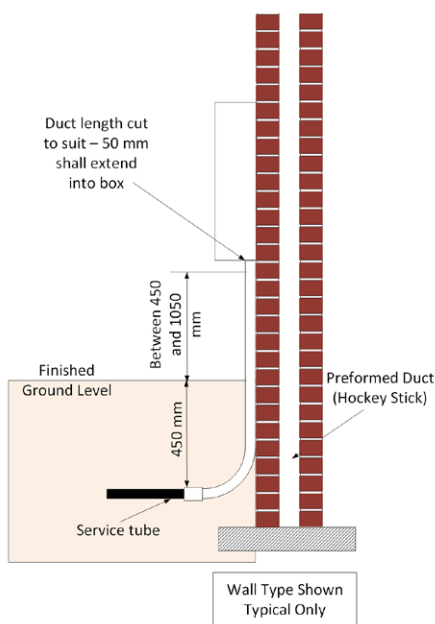

Flush Mounted with External Hockey Stick - Timber Framed

(or similar without full cavity)

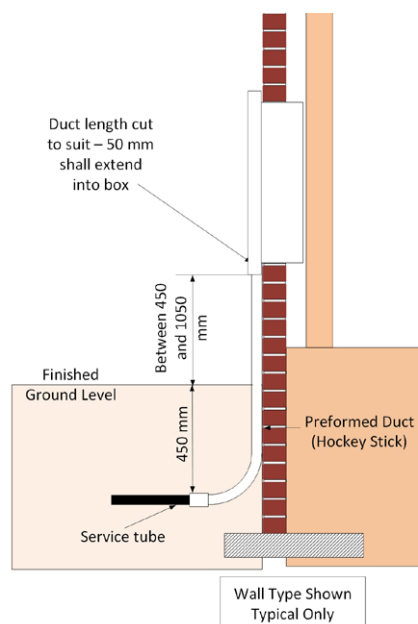

Flush Mounted with External Hockey Stick and Cable Cover - Timber Framed

(or similar without full cavity)

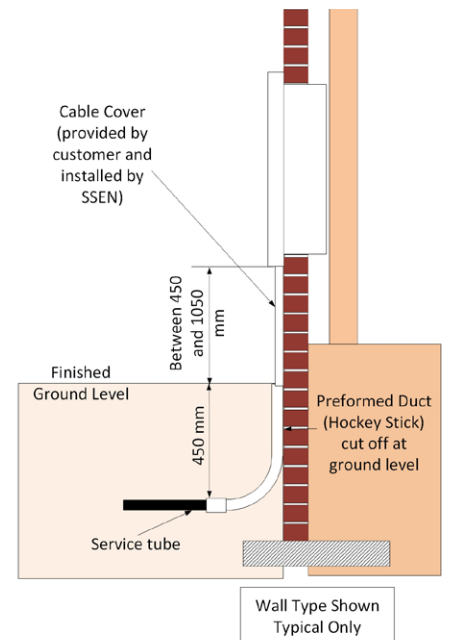

Consumer unit and internal wiring

The length of cable between your supplier's meter and the consumer unit if greater than 3m should incorporate an isolator switch.

You must ensure that any electrical installation work beyond your supplier's meter is carried out by a qualified electrical contractor to the requirements of the current BS 7671.

Your meter installation appointment

You are now ready for your meter installation by your elected electricity supplier.

It is the customer's responsibility to arrange for the meter to be moved.

On the day of your installation your electrician will need to attend your agreed appointment with your electricity supplier. This is to connect your meter tails between the energy supplier's meter and consumer unit or isolator.

Service termination at upper levels

Where connections are to be made to premises on the first floor or above, you must provide and install suitable external or internal containment for the service cable to the termination position. Internal containment must be routed through common areas of the building so that the cable is always accessible, without the need to enter a third party's property, in case of the need for emergency repair.

We will not run our cable in walls, lofts, light shafts, or other cavities not specifically designed to contain cables.

How to reach us



More information

www.ssen.co.uk/connections



Call us

0800 048 3516



Email us

connections@ssen.com

In an emergency situation
call **105** immediately for help

**POWER CUT?
CALL 105**



www.ssen.co.uk



Search 'SSEN Connections Engagement'



twitter.com/ssencommunity



facebook.com/ssencommunity



instagram.com/ssencommunity



Scottish & Southern
Electricity Networks